

THE PROPERTY OF THE DRAWING IS ESTABLISHED BY LAW. IT IS FORBIDDEN TO PRODUCE OR SHOW IT TO THIRD PART. WITHOUT A WRITTEN AGREEMENT.

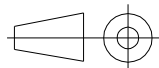
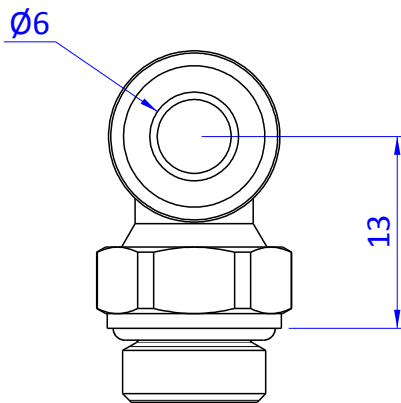
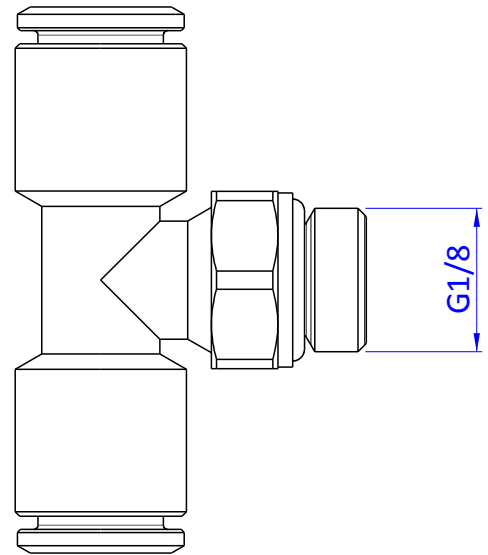
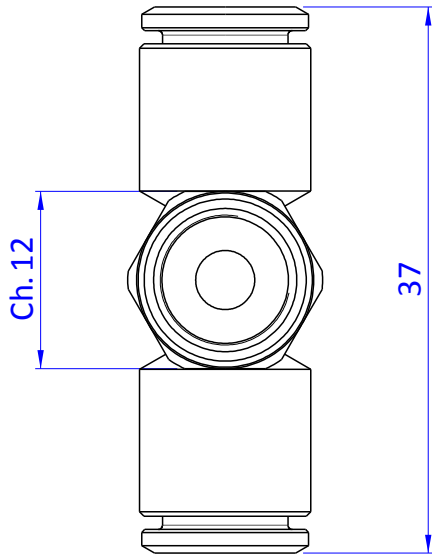
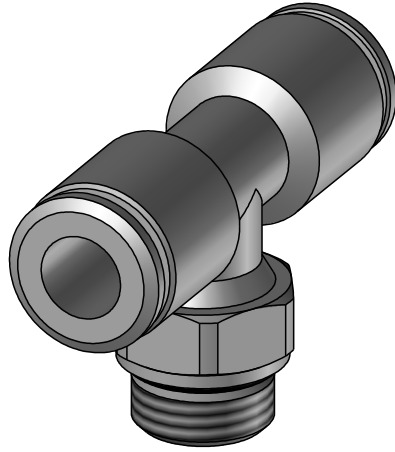

Format A4
UNI 936-76

GENERAL TOLERANCE
UNI - ISO 2768
CLASSE f

DESCRIPTION
CA.12.05.030

DESIGNED FROM FPS Automation		REVIEW A
DATE 18/07/2019	WEIGHT 0.011Kg	
CODE CA.12.05.030		